



ZOR

HAND TOOLS

www.eaglegrouptr.com

Turkey BRANCH:

Cumhuriyet Mahallesi – Nazım Hikmet Bulvarı
No:91 Concept plaza Blok –
Kat: 8 – D:56 Esenyurt - İstanbul -
Mehmet.ezz@eaglegrouptr.com



+905380959929



eaglegrouptrk



eaglegroup

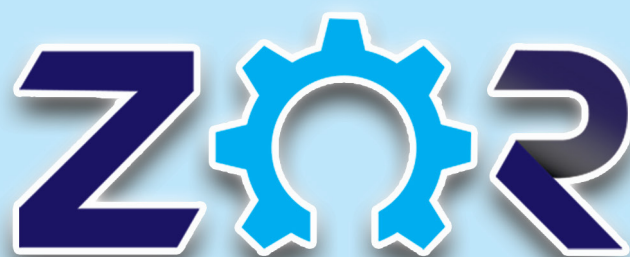

HAND TOOLS

EagleGroup, a privately-owned joint stock Egyptian company established in 2014, offers comprehensive logistics services for international trade.

Since its establishment, Eagle Group became an expert in offering logistics solutions in all modes of transportation, Ocean, Air, and Land. Services vary from facilitating the shipment process on all levels to acquiring the best rates for shipping your cargo to be a hassle-free way to handling the process of importing and exporting goods.



Through a tailored service approach, we provide each customer with a unique solution that fits their individual supply chain. Our integrated logistics services enhance the value of customer's product by reducing product costs and maximizing revenues, giving customers a competitive edge in a continuously challenging global market.

www.eaglegrouptr.com

Mehmet.ezz@eaglegrouptr.com

 +905380959929



DOUBLE OPEN WRENCHES

- Additionally induction hardened precise jaws.
- Made by heat-treated Chrome Vanadium Steel for strength exceeding international specifications.
- Professional plating prevents tools from corrosion.
- Minimized manufacturing tolerances ensures wrenches to fit bolt perfectly.
- Profiles that fit bolt heads easily.

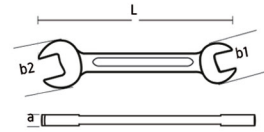

CODE NO	mm	L mm	a mm	b1 mm	b2 mm	WEIGHT	PACKAGE/BOX
RAA0607	6x7	99	4	17	15	18 gr	12/360 Pcs
RAA0809	8x9	110	4	21	19	28 gr	12/360 Pcs
RAA1011	10x11	120	5	24	23	44 gr	12/360 Pcs
RAA1213	12x13	134	6	29	27	64 gr	12/240 Pcs
RAA1415	14x15	147	6	32	30	92 gr	12/240 Pcs
RAA1617	16x17	164	7	38	35	120 gr	12/180 Pcs
RAA1819	18x19	180	7	41	38	148 gr	12/120 Pcs
RAA2022	20x22	192	8	47	41	195 gr	12/120 Pcs
RAA2123	21x23	215	9	48	45	243 gr	6/90Pcs
RAA2427	24x27	235	9	57	51	352 gr	6/60 Pcs
RAA2528	25x28	255	10	60	54	440 gr	6/60 Pcs
RAA3032	30x32	265	11	67	62	548 gr	6/30 Pcs



DOUBLE OPEN WRENCHES SET

- Additionally induction hardened precise jaws.
- Consisting of the most frequently used sizes.
- Made by heat-treated Chrome Vanadium Steel for strength exceeding international specifications.



CODE NO	SET	DETAILS	WEIGHT	PACKAGE/BOX
RAA6722	8pcs	6X7, 8X9, 10X11, 12X13, 14X15, 16X17, 18X19, 20X22 mm	768 gr	1/20 Pcs
RAA6732	12pcs	6X7, 8X9, 10X11, 12X13, 14X15, 16X17, 18X19, 20X22, 21x23, 24x27, 25x28, 30x32 mm	2475 gr	1/10 Pcs

COMBINATION WRENCHES

- Additionally induction hardened precise jaws.
- Profiles that fit bolt heads easily.
- Made by heat-treated Chrome Vanadium Steel for strength exceeding international specifications.

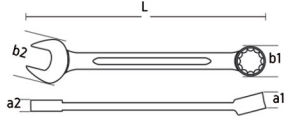

CODE NO	mm	L mm	a1 mm	a2 mm	b1 mm	b2 mm	WEIGHT	PACKAGE/BOX
RKA1006	6	110	5	4	11	15	18 gr	12/360 Pcs
RKA1007	7	121	6	4	12,5	17	27 gr	12/360 Pcs
RKA1008	8	130	6	5	13	18	31 gr	12/360 Pcs
RKA1009	9	141	6,5	5	15	20,5	38 gr	12/360 Pcs
RKA1010	10	150	7	5,5	17	22	42 gr	12/360 Pcs
RKA1011	11	160	7	5,5	17,5	24,5	52 gr	12/360 Pcs
RKA1012	12	170	7,5	5,5	19	26	59 gr	12/360 Pcs
RKA1013	13	180	8,5	6	20	28	70 gr	12/360 Pcs
RKA1014	14	190	9	6	22	30	81 gr	12/240 Pcs
RKA1015	15	200	9	6	23	32	99 gr	12/192 Pcs
RKA1016	16	210	10	7	25	34,5	117 gr	12/180 Pcs
RKA1017	17	220	10	7	26	36,5	134 gr	12/120 Pcs
RKA1018	18	230	11	7	27,5	39	154 gr	12/120 Pcs
RKA1019	19	240	11	7	28	40	177 gr	6/120 Pcs
RKA1020	20	250	11,5	7,5	29,5	42	188 gr	6/90 Pcs
RKA1022	22	270	12	8	32	46	248 gr	6/90 Pcs
RKA1024	24	290	12	8	35	49,5	292 gr	6/90 Pcs
RKA1027	27	320	14	9	39	56	343 gr	6/60 Pcs
RKA1030	30	348	15	10	44	61	526 gr	6/60 Pcs
RKA1032	32	370	15,5	11	46	65	642 gr	6/30 Pcs

COMBINATION WRENCHES SET

- Additionally induction hardened precise jaws.
- Profiles that fit bolt heads easily.
- Made by heat-treated Chrome Vanadium Steel for strength exceeding international specifications.



CODE NO	SET	DETALIS	WEIGHT	PACKAGE/BOX
RKA0822	12pcs	8, 9, 10, 11, 12, 13 14, 15, 16, 17, 19, 22 mm	1327 gr	1/10 Pcs
RKA0632	20pcs	6, 7, 8, 9, 10, 11, 12, 13 14, 15, 16, 17, 18, 19, 21, 22, 24, 27, 30, 32 mm	3699 gr	1/5 Pcs

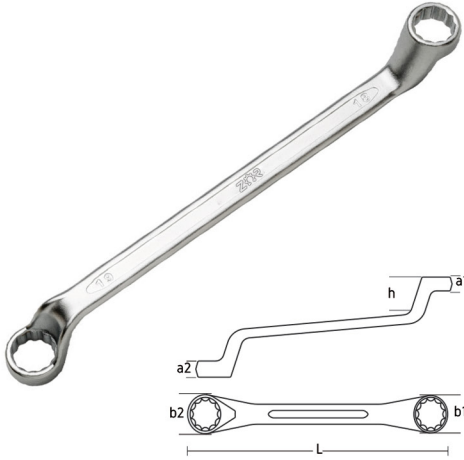

DOUBLE BOX-END WRENCHES

- Additionally induction hardened precise jaws.
- Made by heat-treated Chrome Vanadium Steel for strength exceeding international specifications.
- Professional plating prevents tools from corrosion.
- Minimized manufacturing tolerances ensures wrenches to fit bolt perfectly.
- Profiles that fit bolt heads easily.



KOD NO	mm	L mm	a1 mm	a2 mm	b1 mm	b2 mm	h mm	WEIGHT	PACKAGE/BOX
RYA0607	6x7	165	6	5	13	6	20,7	42 gr	12/360 Pcs
RYA0809	8x9	180	6,6	6	16	9	21,7	58 gr	12/360 Pcs
RYA1011	10x11	195	8,5	7	18	12	23,6	80 gr	12/240 Pcs
RYA1213	12x13	215	9	8	21	20	25,1	112 gr	12/180 Pcs
RYA1415	14x15	230	10	9	24	22	26,1	143 gr	12/120 Pcs
RYA1617	16x17	250	11	10	27	25	27,1	188 gr	12/120 Pcs
RYA1819	18x19	265	11	11	30	28	28,6	223 gr	6/90 Pcs
RYA2022	20x22	285	13	12	34	31	31,0	305 gr	6/90 Pcs
RYA2427	24x27	325	14	13	41	36	34,5	410 gr	6/60 Pcs
RYA2528	25x28	340	15	14	42	38	35,5	483 gr	6/60 Pcs
RYA3032	30x32	375	16	16	47	44	37,4	636 gr	6/30 Pcs
RYA4146	41x46	460	20	20	68	60	42,8	1256 gr	5/15 Pcs



DOUBLE BOX-END WRENCHES SET

- Additionally induction hardened precise jaws.
- Consisting of the most frequently used sizes.
- Made by heat-treated Chrome Vanadium Steel for strength exceeding international specifications



CODE NO	SET	DETAILIS	WEIGHT	PACKAGE/BOX
RYA6722	8pcs	6X7, 8X9, 10X11, 12X13, 14X15, 16X17, 18X19, 20X22 mm	1182 gr	1/10 Pcs

1/4"



CHROME
CrV
VANADIUM



1/4" SLIDING T-HANDLE

- Made by heat-treated CR-V Steel for strength exceeding international specifications.

CODE NO	mm	PACKAGE/BOX
RTK1415	115 mm	50 / 200 Pcs

3/8"



CHROME
CrV
VANADIUM

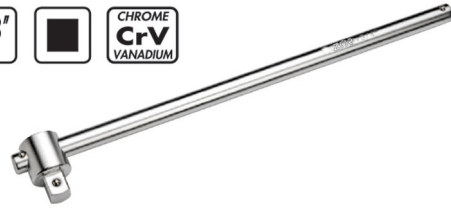

3/8" SLIDING T-HANDLE

- Made by heat-treated CR-V Steel for strength exceeding international specifications.

CODE NO	mm	PACKAGE/BOX
RTK3820	200 mm	24 / 96 Pcs

1/2"



CHROME
CrV
VANADIUM

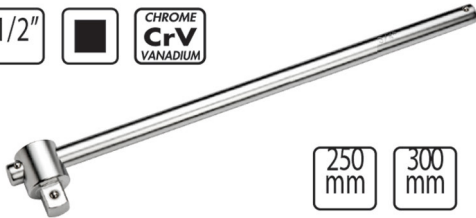

250
mm

300
mm

1/2" SLIDING T-HANDLE

- Made by heat-treated CR-V Steel for strength exceeding international specifications.

CODE NO	mm	PACKAGE/BOX
RTK1225	250 mm	12 / 48 adet
RTK1230	300 mm	12 / 48 adet

1/2"



CHROME
CrV
VANADIUM



1/2" L-HANDLE

- Made by heat-treated CR-V Steel for strength exceeding international specifications.

CODE NO	mm	PACKAGE/BOX
RLU0250	250 mm	10 / 40 Pcs

3/4"



CHROME
CrV
VANADIUM



3/4" T HANDLE

- Made by heat-treated CR-V Steel for strength exceeding international specifications.

CODE NO	mm	PACKAGE/BOX
RTK3445	460 mm	10 / 20 Pcs

1"



CHROME
CrV
VANADIUM



1" T HANDLE

- Made by heat-treated CR-V Steel for strength exceeding international specifications.

CODE NO	mm	PACKAGE/BOX
RTK0155	500 mm	4 / 8 Pcs

SHORT HEX KEY

- Professional plating prevents tools from corrosion.
- Hardened high quality chrome vanadium material.

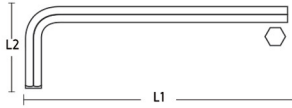

CODE NO	mm	L1 mm	L2 mm	WEIGHT	PACKAGE/BOX
RKL3040	4	73	28	8 gr	24/1800psc
RKL3050	5	84	32,5	13 gr	12/900psc
RKL3060	6	95	37,5	29 gr	12/576psc
RKL3080	8	106	43,5	58 gr	12/384 psc
RKL3100	10	120	49,5	101 gr	12/240 psc
RKL3120	12	135	56,5	163 gr	12/108 psc
RKL3140	14	152	69	253 gr	12/72 psc
RKL3170	17	175	79	433 gr	12/72 psc
RKL3190	19	195	88	602 gr	6/36 psc

EXTRA LONG HEX KEY

- Professional plating prevents tools from corrosion.
- Hardened high quality chrome vanadium material.

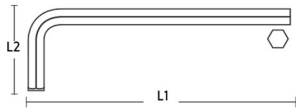

CODE NO	mm	L1 mm	L2 mm	WEIGHT	PACKAGE/BOX
RUL4040	4	143	28	18 gr	24/480 pcs
RUL4050	5	164	32,5	21 gr	24/480 pcs
RUL4060	6	185	37,5	54 gr	12/240 pcs
RUL4080	8	206	43,5	101 gr	12/144 pcs
RUL4100	10	232	49,5	174 gr	12/108 pcs

EXTRA LONG BALL HEAD HEX KEY

- Professional plating prevents tools from corrosion.
- Hardened high quality chrome vanadium material.

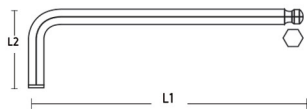
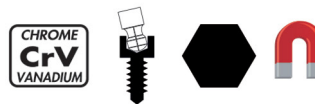

CODE NO	mm	L1 mm	L2 mm	WEIGHT	PACKAGE/BOX
RTB5040	4	143	28	17 gr	24 / 480 adet
RTB5050	5	164	32,5	31 gr	24 / 480 adet
RTB5060	6	185	37,5	52 gr	12 / 240 adet
RTB5080	8	206	43,5	100 gr	12 / 144 adet
RTB5100	10	232	49,5	171 gr	12 / 108 adet

SHORT TX PROFILE KEY

- Professional plating prevents tools from corrosion.
- Hardened high quality chrome vanadium material.



CODE NO		L1 mm	L2 mm	WEIGHT	PACKAGE/BOX
RKT6025	T25	70	25	10 gr	24 / 1800 adet
RKT6027	T27	78	25	15 gr	24 / 1800 adet
RKT6030	T30	86	30	23 gr	12 / 900 adet
RKT6040	T40	97	33	34 gr	12 / 576 adet
RKT6045	T45	110	37	49 gr	12 / 384 adet
RKT6050	T50	122	40	56 gr	12 / 384 adet

EXTRA LONG TX PROFILE KEY

- Professional plating prevents tools from corrosion.
- Hardened high quality chrome vanadium material.



CODE NO		L1 mm	L2 mm	WEIGHT	PACKAGE/BOX
RUT8025	T25	130	25	18 gr	24 / 1800 adet
RUT8027	T27	145	29	26 gr	24 / 1800 adet
RUT8030	T30	165	35	40 gr	12 / 900 adet
RUT8040	T40	183	39	60 gr	12 / 576 adet
RUT8045	T45	200	44	90 gr	12 / 384 adet
RUT8050	T50	225	52	124 gr	12 / 384 adet

SHORT TEMPERED TX PROFILE KEY

- Professional plating prevents tools from corrosion.
- Hardened high quality chrome vanadium material.



CODE NO		L1 mm	L2 mm	WEIGHT	PACKAGE/BOX
RKD7025	T 25	70	25	11 gr	12 / 900 adet
RKD7027	T 27	78	25	12 gr	12 / 900 adet
RKD7030	T 30	86	30	21 gr	12 / 576 adet
RKD7040	T40	97	33	35 gr	12 / 576 adet
RKD7045	T45	110	37	47 gr	12 / 576 adet
RKD7050	T 50	122	40	52 gr	12 / 576 adet

EXTRA LONG TEMPERED TX PROFILE KEY

- Professional plating prevents tools from corrosion.
- Hardened high quality chrome vanadium material.



CODE NO		L1 mm	L2 mm	WEIGHT	PACKAGE/BOX
RUD9025	T 25	130	25	18 gr	24 / 1800 adet
RUD9027	T 27	145	29	22 gr	24 / 1800 adet
RUD9030	T 30	165	35	40 gr	12 / 900 adet
RUD9040	T 40	183	39	63 gr	12 / 576 adet
RUD9045	T 45	200	44	84 gr	12 / 384 adet
RUD9050	T 50	225	52	125 gr	12 / 384 adet

9
PCS



SHORT HEX KEY SET

- Professional plating prevents tools from corrosion.
- Hardened high quality chrome vanadium material.
- ABS clips enables the easy selection of sizes.



CODE NO	SET	DETAILS	WEIGHT	PACKAGE/BOX	PRICE
RAT3009	9 pcs	1,5 mm, 2 mm, 2,5 mm, 3 mm, 4 mm, 5 mm, 6 mm, 8 mm, 10 mm	256 gr	12 / 72 adet	\$ 7,00

9
PCS



EXTRA LONG HEX KEY SET

- Professional plating prevents tools from corrosion.
- Hardened high quality chrome vanadium material.
- ABS clips enables the easy selection of sizes.



CODE NO	SET	DETAILS	WEIGHT	PACKAGE/BOX	PRICE
RAT4009	9 pcs	1,5 mm, 2 mm, 2,5 mm, 3 mm, 4 mm, 5 mm, 6 mm, 8 mm, 10 mm	418 gr	12 / 48 adet	\$ 9,75

9
PCS



EXTRA LONG BALL HEAD HEX KEY SET

- Professional plating prevents tools from corrosion.
- Hardened high quality chrome vanadium material.
- ABS clips enables the easy selection of sizes.
- Enables to work with a 30° angle.



CODE NO	SET	DETAILS	WEIGHT	PACKAGE/BOX	PRICE
RAT5009	9 pcs	1,5 mm, 2 mm, 2,5 mm, 3 mm, 4 mm, 5 mm, 6 mm, 8 mm, 10 mm	422 gr	12 / 48 adet	\$ 11,00

SHORT TX PROFILE KEY SET

- Professional plating prevents tools from corrosion.
- Hardened high quality chrome vanadium material.
- ABS clips enables the easy selection of sizes.



CODE NO	SET	DETAILS	WEIGHT	PACKAGE/BOX
RAT6009	9pcs	T10, T15, T20, T25, T27, T30, T40, T45, T50	250 gr	12 / 72 adet

EXTRA LONG TX PROFILE KEY SET

- Professional plating prevents tools from corrosion.
- Hardened high quality chrome vanadium material.
- ABS clips enables the easy selection of sizes.



CODE NO	SET	DETAILS	WEIGHT	PACKAGE/BOX
RAT8009	9pcs	T10, T15, T20, T25, T27, T30, T40, T45, T50	421 gr	12 / 48 adet

SHORT TEMPERED TX PROFILE KEY SET

- Professional plating prevents tools from corrosion.
- Hardened high quality chrome vanadium material.
- ABS clips enables the easy selection of sizes.



CODE NO	SET	DETAILS	WEIGHT	PACKAGE/BOX
RAT7009	9pcs	T10, T15, T20, T25, T27, T30, T40, T45, T50	247 gr	12 / 48 adet

EXTRA LONG TEMPERED TX PROFILE KEY SET

- Professional plating prevents tools from corrosion.
- Hardened high quality chrome vanadium material.
- ABS clips enables the easy selection of sizes.



CODE NO	SET	DETAILS	WEIGHT	PACKAGE/BOX
RAT9009	9pcs	T10, T15, T20, T25, T27, T30, T40, T45, T50	418 gr	12 / 48 adet



T HANDLE HEX KEY

- Specially designed ergonomic handle.
- Hot rolled, hardened and tempered CR-V material.
- Professional plating prevents tools from corrosion.

CHROME
CrV
VANADIUM

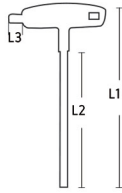

CODE NO	mm	L1 mm	L2 mm	L3 mm	WEIGHT	PACKAGE/BOX
RXA1020	2	135	94	18	34 gr	12 / 96 adet
RXA1025	2.5	145	104	18	36 gr	12 / 96 adet
RXA1030	3	155	116	18	39 gr	12 / 96 adet
RXA1040	4	175	125	22	70 gr	12 / 96 adet
RXA1050	5	195	145	22	85 gr	12 / 96 adet
RXA1060	6	215	167	22	109 gr	12 / 96 adet
RXA1080	8	245	183	28	207 gr	12 / 96 adet



T HANDLE BALL HEAD HEX KEY

- Specially designed ergonomic handle.
- Hot rolled, hardened and tempered CR-V material.
- Professional plating prevents tools from corrosion.

CHROME
CrV
VANADIUM

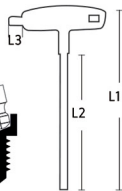

CODE NO	mm	L1 mm	L2 mm	L3 mm	WEIGHT	PACKAGE/BOX
RTB2020	2	135	90	15	33 gr	12 / 96 adet
RTB2025	2.5	145	103	15	36 gr	12 / 96 adet
RTB2030	3	157	117	18	39 gr	12 / 96 adet
RTB2040	4	175	125	21	69 gr	12 / 96 adet
RTB2050	5	195	144	22	85 gr	12 / 96 adet
RTB2060	6	220	168	22	107 gr	12 / 96 adet
RTB2080	8	245	184	28	207 gr	12 / 96 adet



T HANDLE TX PROFILE KEY

- Specially designed ergonomic handle.
- Hot rolled, hardened and tempered CR-V material.
- Professional plating prevents tools from corrosion.

CHROME
CrV
VANADIUM

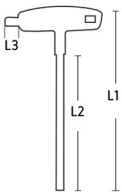

CODE NO	mm	L1 mm	L2 mm	L3 mm	WEIGHT	PACKAGE/BOX
RXT2010	T10 x 100 mm	140	100	12	38 gr	12 / 96 adet
RXT2015	T15 x 100 mm	140	100	12	38 gr	12 / 96 adet
RXT2020	T20 x 100 mm	140	100	12	38 gr	12 / 96 adet
RXT2025	T25 x 150 mm	200	150	20	107 gr	12 / 96 adet
RXT2030	T30 x 150 mm	200	150	20	108 gr	12 / 96 adet
RXT2040	T40 x 150 mm	200	150	20	110 gr	12 / 96 adet

T HANDLE HEX KEY SET

- Specially designed ergonomic handle.
- Hot rolled, hardened and tempered CR-V material.
- Professional plating prevents tools from corrosion.

6
PCS



CODE NO	SET	DETAILS	WEIGHT	PACKAGE/BOX
RTA0600	6 pcs	2.5mm, 3mm, 4mm, 5mm, 6mm, 8mm	713 gr	1 / 12 adet

T HANDLE BALL HEAD HEX KEY SET

- Specially designed ergonomic handle.
- Hot rolled, hardened and tempered CR-V material.
- Professional plating prevents tools from corrosion.

6
PCS



CODE NO	SET	DETAILS	WEIGHT	PACKAGE/BOX
RTB2000	6 pcs	2,5mm, 3mm, 4mm, 5mm, 6mm, 8mm	576 gr	1 / 12 adet

T HANDLE TX PROFILE KEY SET

- Specially designed ergonomic handle.
- Hot rolled, hardened and tempered CR-V material.
- Professional plating prevents tools from corrosion.

6
PCS



CODE NO	SET	DETAILS	WEIGHT	PACKAGE/BOX
RTA0603	6 pcs	T10, T15, 20, T25, T30, T40	582 gr	1 / 12 adet

RX SERIES SCREWDRIVERS

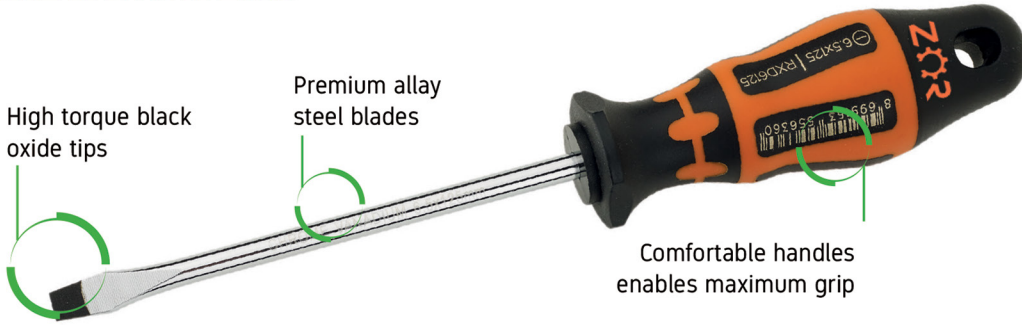



RX SERIES SCREWDRIVER

- Manufactured from high-quality chrome vanadium steel.
- Screwdriver bits are machined to fit the precise dimensions.
- Blacken and magnetized tip.

CODE NO	mm	PACKAGE/ BOX
RXK3075	3 x 75 mm	12 / 96 adet
RXK3100	3 x 100 mm	12 / 96 adet
RXK3125	3 x 125 mm	12 / 96 adet
RXK4100	4 x 100 mm	12 / 96 adet
RXK4125	4 x 125 mm	12 / 96 adet



RX SERIES SLOTTED SCREWDRIVER

- Manufactured from high-quality chrome vanadium steel.
- Screwdriver bits are machined to fit the precise dimensions.
- Blacken and magnetized tip.

CODE NO	mm	PACKAGE/ BOX
RXD5100	5.0 x 100 mm	12 / 96 adet
RXD5125	5.0 x 125 mm	12 / 96 adet
RXD5150	5.0 x 150 mm	12 / 96 adet
RXD5200	5.0 x 200 mm	12 / 96 adet
RXD5300	5.0 x 300 mm	12 / 96 adet
RXD6100	6.0 x 100 mm	12 / 96 adet
RXD6125	6.5 x 125 mm	12 / 96 adet
RXD6150	6.5 x 150 mm	12 / 96 adet
RXD8150	8.0 x 150 mm	12 / 96 adet
RXD8200	8.0 x 200 mm	12 / 96 adet

RX SERIES CROS-HEAD SCREWDRIVER



- Manufactured from high-quality chrome vanadium steel.
- Screwdriver bits are machined to fit the precise dimensions.
- Blacken and magneted tip.

CODE NO	mm	PACKAGE/ BOX
RXY3080	PH0 x 80 mm	12 / 96 adet
RXY3125	PH0 x 125 mm	12 / 96 adet
RXY4100	PH1 x 100 mm	12 / 96 adet
RXY4125	PH1 x 125 mm	12 / 96 adet
RXY5100	PH1 x 100 mm	12 / 96 adet
RXY5125	PH1 x 125 mm	12 / 96 adet
RXY5150	PH1 x 150 mm	12 / 96 adet
RXY5200	PH1 x 200 mm	12 / 96 adet
RXY5300	PH1 x 300 mm	12 / 96 adet
RXY6100	PH2 x 100 mm	12 / 96 adet
RXY6125	PH2 x 125 mm	12 / 96 adet
RXY6150	PH2 x 150 mm	12 / 96 adet
RXY8150	PH3 x 150 mm	12 / 96 adet



RX SERIES TX PROFILE TEMPERED SCREWDRIVER



- Manufactured from high-quality chrome vanadium steel.
- Screwdriver bits are machined to fit the precise dimensions.
- Blacken and magneted tip.

CODE NO	mm	PACKAGE/ BOX
RXT0010	T10 x 80 mm	12 / 96 adet
RXT0015	T15 x 80 mm	12 / 96 adet
RXT0020	T20 x 100 mm	12 / 96 adet
RXT0025	T25 x 100 mm	12 / 96 adet
RXT0027	T27 x 115 mm	12 / 96 adet
RXT0030	T30 x 115 mm	12 / 96 adet



RX SERIES TX PROFILE SCREWDRIVER



- Manufactured from high-quality chrome vanadium steel.
- Screwdriver bits are machined to fit the precise dimensions.
- Blacken and magneted tip.

CODE NO	mm	PACKAGE/ BOX
RXT1010	T10 x 80 mm	12 / 96 adet
RXT1015	T15 x 80 mm	12 / 96 adet
RXT1020	T20 x 100 mm	12 / 96 adet
RXT1025	T25 x 100 mm	12 / 96 adet
RXT1027	T27 x 115 mm	12 / 96 adet
RXT1030	T30 x 115 mm	12 / 96 adet





RX SERIES POZIDRIVE SCREWDRIVER



- Manufactured from high-quality chrome vanadium steel.
- Screwdriver bits are machined to fit the precise dimensions.
- Blacken and magneted tip.

CODE NO	mm	PACKAGE / BOX
RXZ3060	PZ0 x60 mm	12 / 96 adet
RXZ6150	PZ2 x150 mm	12 / 96 adet



R-PLUS STUBBY SCREWDRIVER



- Manufactured from high-quality chrome vanadium steel.
- Screwdriver bits are machined to fit the precise dimensions.
- Blacken and magneted tip.

CODE NO	mm	PACKAGE / BOX
RXD6045	6.0 x 45 mm	12 / 96 adet



R-PLUS STUBBY SCREWDRIVER



- Manufactured from high-quality chrome vanadium steel.
- Screwdriver bits are machined to fit the precise dimensions.
- Blacken and magneted tip.

CODE NO	mm	PACKAGE / BOX
RXY5045	PH1x45 mm	12 / 96 adet
RXY6045	PH2x45 mm	12 / 96 adet



R-PLUS STUBBY SCREWDRIVER



- Manufactured from high-quality chrome vanadium steel.
- Screwdriver bits are machined to fit the precise dimensions.
- Blacken and magneted tip.

CODE NO	mm	PACKAGE / BOX
RXZ6045	PZ2x45 mm	12 / 96 adet

RX SERIES NUTDRIVER

- Manufactured from high-quality chrome vanadium steel.
- Nutdriver bits are machined to fit the precise dimensions.

CODE NO	mm	PACKAGE/ BOX
RXL1005	5.5 x 125 mm	12 / 120 adet
RXL1006	6 x 125 mm	12 / 120 adet
RXL1007	7 x 125 mm	12 / 120 adet
RXL1008	8 x 125 mm	12 / 120 adet
RXL1009	9 x 125 mm	12 / 120 adet
RXL1010	10 x 125 mm	12 / 120 adet
RXL1011	11 x 125 mm	12 / 120 adet
RXL1012	12 x 125 mm	12 / 120 adet
RXL1013	13 x 125 mm	12 / 120 adet



RX SERIES BIT HOLDER

CODE NO	mm	PACKAGE/ BOX
RBT0115	115mm	1 / 24 adet



RX SERIES SCREWDRIVER SET



- Manufactured from high-quality chrome vanadium steel.
- Screwdriver bits are machined to fit the precise dimensions.
- Blacken and magneted tip.

CODE NO	DETAILS	PACKAGE/ BOX
RXS6000	6 pcs	1 / 24 adet



RX SERIES SCREWDRIVER SET



- Manufactured from high-quality chrome vanadium steel.
- Screwdriver bits are machined to fit the precise dimensions.
- Blacken and magneted tip. ☉ T10, T15, T20, T25, T27, T30

CODE NO	DETAILS	PACKAGE/ BOX
RXT6000	6 pcs	1 / 24 adet



RX SERIES NUTDRIVER SET



- ☉ 6.0x125, 7.0x125, 8.0x125, 10.0x125, 13.0x125 mm

CODE NO	DETAILS	PACKAGE/ BOX
RXL5000	5 pcs	1 / 24 adet





CIRCLIP PLIER EXTERNAL STRAIGHT

- Manufactured from high-quality chrome vanadium steel.
- Black phosphate coated surface and PVC dipped handles.
- Invisible spring mechanism.
- Used for safety rings.

CODE NO	mm	PACKAGE/BOX
RSP0710	180 mm	6 / 60 adet



CIRCLIP PLIER INTERNAL STRAIGHT

- Manufactured from high-quality chrome vanadium steel.
- Black phosphate coated surface and PVC dipped handles.
- Invisible spring mechanism.
- Used for safety rings.

CODE NO	mm	PACKAGE/BOX
RSP0720	180 mm	6 / 60 adet



CIRCLIP PLIER EXTERNAL BENT

- Manufactured from high-quality chrome vanadium steel.
- Black phosphate coated surface and PVC dipped handles.
- Invisible spring mechanism.
- Used for safety rings.

CODE NO	mm	PACKAGE/BOX
RSP0715	180 mm	6 / 60 adet



CIRCLIP PLIER INTERNAL BENT

- Manufactured from high-quality chrome vanadium steel.
- Black phosphate coated surface and PVC dipped handles.
- Invisible spring mechanism.
- Used for safety rings.

CODE NO	mm	PACKAGE/BOX
RSP0725	180 mm	6 / 60 adet



OIL FILTER PLIER

- With adjustable knob fits many sizes and dimensions
- Dipped PVC handle.

CODE NO	mm	PACKAGE/BOX
RFP6090	60-90 mm	6 / 60 adet
RFP8515	85-115 mm	12 / 48 adet



WATER PUMP PLIER

- Manufactured from High Quality Chrome Vanadium Steel
- Black Magnesium Phosphate coating

CODE NO	mm	PACKAGE/BOX
RFP1255	250 mm	6 / 60 adet



MACHINIST HAMMER

- Electro- inductive hardened stell.
- Smoothed, cacquered with polished striking faces and blunt edges.

CODE NO	GR	PACKAGE/BOX	PRICE
RTC0100	100 gr.	12/ 120 adet	\$ 2,15
RTC0200	200 gr.	12 / 72 adet	\$ 2,90
RTC0300	300 gr.	12 / 72 adet	\$ 4,00
RTC0500	500 gr.	12 / 72 adet	\$ 5,50
RTC1000	1000 gr.	6 / 36 adet	\$ 8,00



FLAT CHISEL

- Manufactured from high-quality chrome vanadium steel.
- Cutting re-shaping and lifting softer metals.
- Tips can be re-sharpen.

CODE NO	mm	PACKAGE/BOX
REK2015	150 mm	12 / 120 adet
REK2620	200 mm	12 / 72 adet
REK2925	250 mm	10 / 20 adet



2 JAW GEAR PULLER

- Heavy duty twin leg bar type puller.
- Drop-forged chrome vanadium steel.
- Chrome plated for corrsion resistance.

CODE NO	mm	PACKAGE/BOX
RCY0100	120x100 mm	1 / 8 pcs
RCY0150	160x150 mm	1 / 8 pcs
RCY0200	200x150 mm	1 / 8 pcs



COIL SPRING COMPRESSOR

- Used for Shock removing absorber spring safely.

CODE NO	mm	PACKAGE/BOX
RAC0124	370 mm	1 / 10 adet



OIL FILTER WRENCH

- Used for removing oil filters on commercial vehicles.
- Can be used for air dryer cartridge.

CODE NO	mm	PACKAGE/BOX
RFA6110	60-110 mm	1 / 12 pcs



TIRE LEVER

- Tempered drop forged steel with one piece quality steel construction
- Suitable for levering tire on / off car or motorbike rims

CODE NO	mm	PACKAGE/BOX
ROL0500	500 mm	1/10 pcs
ROL0600	600 mm	1/10 pcs



REVERSIBLE CHAIN PIPE WRENCH

- Chain pipe wrench for mounting and unmounting pipes etc.
- Manufactured from high-quality chrome vanadium steel.

CODE NO	mm	PACKAGE/BOX
RZB0009	225 mm	6 / 36 adet



AXIAL JOINT INSTALLER REMOVER

- Works with 27mm wrench size.
- Automatic clamping of the join heads.

CODE NO	mm	PACKAGE/BOX
RDK0250	28-35 mm	1 / 10 adet
RDK0400	35-45mm	1 / 10 adet



STRAP WRENCH

- Special-purpose oil filter strap wrench
- One piece forged construction for maximum strength and durability
- Rubber coated on the strong woven strap to prevent slipping
- Perfect use for polished pipes, plastic pipes and fittings against with scratch damage or deformation

CODE NO	mm	PACKAGE/BOX
RKB0009	225 mm	6 / 60 adet



STRAP WRENCH

- Special-purpose oil filter strap wrench
- One piece forged construction for maximum strength and durability
- Rubber coated on the strong woven strap to prevent slipping
- Perfect use for polished pipes, plastic pipes and fittings against with scratch damage or deformation

CODE NO	mm	PACKAGE/BOX
RKB0012	275 mm	5 / 30 adet



TRIM REMOVAL TOOL

- For removing door panel clips.

CODE NO	mm	PACKAGE/BOX
RDS0175	175 mm	12 / 36 adet



OIL DRAIN PLUP WRENCH

- Black fasfat cated.
- Suitable for the removal of drain and filler plugs on pearbox sump and drive axles of popular vehicles.

CODE NO	mm	PACKAGE/BOX
RKT0215	8 x 10 mm	1 / 10 pcs



SEAL RING REMOVER STRANGTH

- For the removal and insertion of seals and 0-rings.
- İdal for hart to reach places

CODE NO	mm	PACKAGE/BOX
RXB0100	250 mm	1 / 12 adet



SEAL RING REMOVER - 45 DEGREE

- For the removal and insertion of seals and 0-rings.
- İdal for hart to reach places

CODE NO	mm	PACKAGE/BOX
RXB0145	250 mm	1 / 12 adet



SEAL RING REMOVER - 90 DEGREE

- Otomotiv ve hobi kullanım için.
- Birçok çekme ve işaretleme işlerinde kullanılır.

CODE NO	mm	PACKAGE/BOX
RXB0190	250 mm	1 / 12 adet



SEAL RING REMOVER - HOOK

- Otomotiv ve hobi kullanım için.
- Birçok çekme ve işaretleme işlerinde kullanılır.

CODE NO	mm	PACKAGE/BOX
RXB0360	250 mm	1 / 12 adet



OIL CAN MANUAL PUMP

- Oil can for multiple purpose lubrications.
- Made from high prade steel for long lasting usape.

CODE NO	cc	PACKAGE/BOX
RPY0350	350 cc	1/90 adet
RPY0500	500 cc	1/60 adet
RPY1000	1000 cc	1/50 adet



JACK STAND

- Heavy duty steel frames.
- Ratcheting duclite iron masts.
- Double locking mobility for extra safety.

CODE NO	CAPACITY	PACKAGE/BOX
RAS3001	3 TON	2 adet



ZOR



PH2 x 100



Magnetic



Açıklama	Kutu Adetl	Koll Adetl
PH1x25	60	40
PH1x50	30	40
PH1x75	20	40
PH1x100	10	70
PH1x150	10	50
PH2x25	60	40
PH2x50	30	40
PH2x75	20	40
PH2x100	10	70
PH2x150	10	50
PH2x200	10	40
PH2x300	10	20
PH3x25	60	40
PH3x50	30	40
PH3x75	20	40

PH2 x 100

ZOR



ZOR



TORSION



PH2 × 25

10 Pcs.



Magnetic

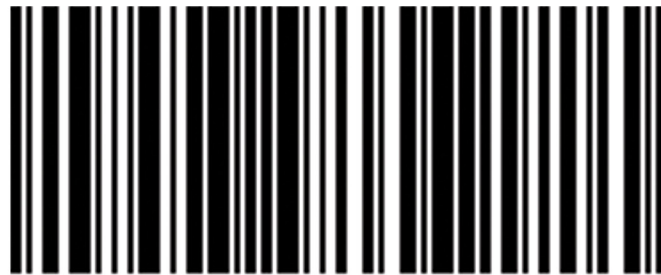

8683608903496



TORSION



PZ2 × 100

25 Pcs.



PZ2 × 100



Impact
Control

Magnetic

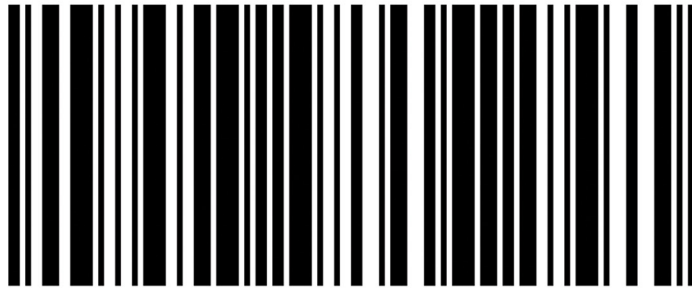

8683608903465

ZOR



PZ2 x 50

Kod	Açıklama	Kutu Adeti	Koli Adeti
CT20001	PZ1x25	60	40
CT20002	PZ1x50	30	40
CT20003	PZ2x25	60	40
CT20004	PZ2x50	30	40
CT20005	PZ2x75	20	40
CT20006	PZ2x100	10	70
CT20007	PZ2x150	10	50
CT20008	PZ3x25	60	40
CT20009	PZ3x50	30	40
CT20010	PZ3x75	20	40

Magnetic



30 Pcs.

ZOR

professional utility knife



Açıklama	Kutu Adeti	Koli Adeti
Alüminyum	1	300

30 Pcs.

ZOR

345 ml. professional epoxy gun

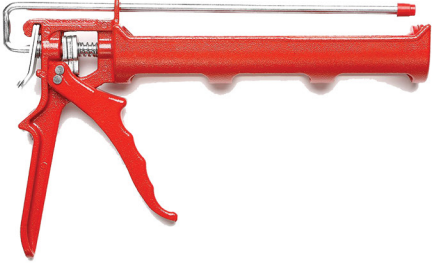

Açıklama	Kutu Adeti	Koll Adeti
Alüminyum	1	25

410 ml. professional epoxy gun



Açıklama	Kutu Adeti	Koll Adeti
Alüminyum	1	25

310 ml. professional epoxy gun



Açıklama	Kutu Adeti	Koll Adeti
Alüminyum	1	25

310 ml. professional epoxy gun



Açıklama	Kutu Adeti	Koll Adeti
Alüminyum	1	25

400 ml. sausage gun



Açıklama	Kutu Adeti	Koll Adeti
Alüminyum	1	25

600 ml. sausage gun



Açıklama	Kutu Adeti	Koll Adeti
Alüminyum	1	25

ZOR

20 mt. 3-way extension cable



Açıklama	Kutu Adeti	Koli Adeti
3 x 1.5	1	10

10 mt. 3-way extension cable



Açıklama	Kutu Adeti	Koli Adeti
3 x 1.5	1	10

20 mt. 3-way extension cable



Açıklama	Kutu Adeti	Koli Adeti
3 x 2.5	1	10

30 mt. 3-way extension cable



Açıklama	Kutu Adeti	Koli Adeti
3 x 1.5	1	10



10 mt. 3-way extension cable



Açıklama	Kutu Adeti	Koli Adeti
3 x 2.5	1	10

ZOR

20 mt. 3-way extension cable



Açıklama	Kutu Adeti	Koli Adeti
3 x 1.5	1	10

10 mt. 3-way extension cable



Açıklama	Kutu Adeti	Koli Adeti
3 x 1.5	1	10

20 mt. 3-way extension cable



Açıklama	Kutu Adeti	Koli Adeti
3 x 2.5	1	10

30 mt. 3-way extension cable



Açıklama	Kutu Adeti	Koli Adeti
3 x 1.5	1	10



30 mt. 3-way extension cable



Açıklama	Kutu Adeti	Koli Adeti
3 x 2.5	1	10

ZOR

movable reel cable

35 mt.
40 mt.
50 mt.

Açıklama	Kutu Adeti	Koli Adeti
3 x 2.5	1	4



portable reel cable with bag

20 mt.
30 mt.
35 mt.
50 mt.

Açıklama	Kutu Adeti	Koli Adeti
3 x 1.5	1	4

Açıklama	Kutu Adeti	Koli Adeti
3 x 2.5	1	4



MONOLINE
THE PROFESSIONAL GARAGE TOOLS

TOOL CHART - 1010

- Sheet steel, corrosion-resistant and scratch-resistant powder coating.
- Bolted steel construction.
- 4 Castors \varnothing 100mm: 2 fixed and 2steering (one with brake)

h	Max
3 cm	35 kg

CODE NO	HEIGHT	WIDTH	DEPTH
RTA1010	90 cm	60 cm	45 cm

MONOLINE
THE PROFESSIONAL GARAGE TOOLS

TOOL CHART - 1020

- Sheet steel, corrosion-resistant and scratch-resistant powder coating.
- Bolted steel construction.
- 4 Castors \varnothing 100mm: 2 fixed and 2steering (one with brake)

h	Max
3 cm	35 kg

CODE NO	HEIGHT	WIDTH	DEPTH
RTA1020	90 cm	75 cm	45 cm

PROLINE
THE PROFESSIONAL GARAGE TOOLS

MINI TROLLEY

- Sheet steel, corrosion-resistant and scratch-resistant powder coating.
- Under seat storage for tools, parts&accessories.
- 30 EVA foam seat for maximum comfort.

CODE NO	HEIGHT	WIDTH	DEPTH
RTA9000	50 cm	40 cm	45 cm

MONOLINE
THE PROFESSIONAL GARAGE TOOLS

TOOL CHART - 1030

- Sheet steel, corrosion-resistant and scratch-resistant powder coating.
- Fully opening drawer on telescopic ball bearing slides
- 4 Castors \varnothing 100mm: 2 fixed and 2 steering (one with brake)

CODE NO	HEIGHT	WIDTH	DEPTH
RTA1030	90 cm	75 cm	45 cm

MONOLINE
THE PROFESSIONAL GARAGE TOOLS

TOOL CHART - 1040

- Sheet steel, corrosion-resistant and scratch-resistant powder coating.
- Fully opening drawer on telescopic ball bearing slides
- 4 Castors \varnothing 100mm: 2 fixed and 2 steering (one with brake)

h	Max
3x10 cm	35 kg

CODE NO	HEIGHT	WIDTH	DEPTH
RTA1040	90 cm	80 cm	45 cm

MONOLINE
THE PROFESSIONAL GARAGE TOOLS

TOOL CHART - 1060

- Sheet steel, corrosion-resistant and scratch-resistant powder coating.
- Fully opening drawer on telescopic ball bearing slides
- 4 Castors \varnothing 100mm: 2 fixed and 2 steering (one with brake)

h	Max
4x13,5 cm	35 kg

CODE NO	HEIGHT	WIDTH	DEPTH
RTA1060	90 cm	80 cm	45 cm

MONOLINE
THE PROFESSIONAL GARAGE TOOLS

TOOL TROLLEY - 5 DRAWERS

- Sheet steel, corrosion-resistant and scratch-resistant powder coating.
- Fully opening drawer on telescopic ball bearing slides.
- 4 Castors \varnothing 100mm: 2 fixed and 2 steering (one with brake)
- ABS reinforced worktop, solid and sturdy.

h	Max
4x 10 cm	35 kg
20 cm	35 kg

CODE NO	HEIGHT	WIDTH	DEPTH	WEIGHT
RTA5001	90 cm	67,5 cm	45 cm	48,50 kg

PROLINE
THE PROFESSIONAL GARAGE TOOLS

TOOL TROLLEY - 5 DRAWERS

- Sheet steel, corrosion-resistant and scratch-resistant powder coating.
- Fully opening drawer on telescopic ball bearing slides.
- 4 Castors \varnothing 100mm: 2 fixed and 2 steering (one with brake)
- ABS reinforced worktop, solid and sturdy.

h	Max
4x 10 cm	35 kg
20 cm	35 kg

CODE NO	HEIGHT	WIDTH	DEPTH	WEIGHT
RTY5001	90 cm	75,5 cm	45 cm	56,24 kg

MONOLINE

THE PROFESSIONAL GARAGE TOOLS

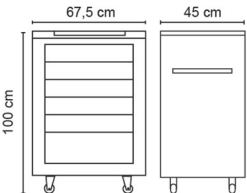
TOOL TROLLEY - 6 DRAWERS

- Sheet steel, corrosion-resistant and scratch-resistant powder coating.
- Fully opening drawer on telescopic ball bearing slides.
- 4 Castors ø 100mm: 2 fixed and 2 steering (one with brake)
- ABS reinforced worktop, solid and sturdy.

h	Max
5x 10 cm	35 kg
20 cm	35 kg



CODE NO	HEIGHT	WIDTH	DEPTH	WEIGHT	PRICE
RTA6001	100 cm	67,5 cm	45 cm	55,76 kg	\$ 325,00

PROLINE

THE PROFESSIONAL GARAGE TOOLS

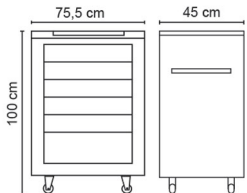
TOOL TROLLEY - 6 DRAWERS

- Sheet steel, corrosion-resistant and scratch-resistant powder coating.
- Fully opening drawer on telescopic ball bearing slides.
- 4 Castors ø 100mm: 2 fixed and 2 steering (one with brake)
- ABS reinforced worktop, solid and sturdy.

h	Max
5x 10 cm	35 kg
20 cm	35 kg



CODE NO	HEIGHT	WIDTH	DEPTH	WEIGHT	PRICE
RTY6001	100 cm	75,5 cm	45 cm	60,70 kg	\$ 355,00

MONOLINE

THE PROFESSIONAL GARAGE TOOLS



TOOL TROLLEY - 7 DRAWERS

- Sheet steel, corrosion-resistant and scratch-resistant powder coating.
- Fully opening drawer on telescopic ball bearing slides.
- 4 Castors ø 100mm: 2 fixed and 2 steering (one with brake)
- ABS reinforced worktop, solid and sturdy.

h	Max
6x 8,2 cm	35 kg
117 cm	35 kg



CODE NO	HEIGHT	WIDTH	DEPTH	WEIGHT	PRICE
RTA7001	90 cm	67,5 cm	45 cm	48,50 kg	\$ 360,00

PROLINE

THE PROFESSIONAL GARAGE TOOLS

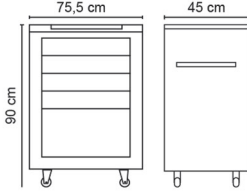
TOOL TROLLEY - 7 DRAWERS

- Sheet steel, corrosion-resistant and scratch-resistant powder coating.
- Fully opening drawer on telescopic ball bearing slides.
- 4 Castors ø 100mm: 2 fixed and 2 steering (one with brake)
- ABS reinforced worktop, solid and sturdy.

h	Max
6x 8,2 cm	35 kg
117 cm	35 kg



CODE NO	HEIGHT	WIDTH	DEPTH	WEIGHT	PRICE
RTY7001	90 cm	77,5 cm	45 cm	56,50 kg	\$ 390,00

MONOLINE

THE PROFESSIONAL GARAGE TOOLS



TOOL TROLLEY - 8 DRAWERS

- Sheet steel, corrosion-resistant and scratch-resistant powder coating.
- Fully opening drawer on telescopic ball bearing slides.
- 4 Castors ø 100mm: 2 fixed and 2 steering (one with brake)
- ABS reinforced worktop, solid and sturdy.

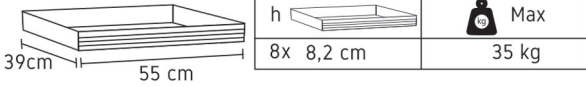

CODE NO	HEIGHT	WIDTH	DEPTH	WEIGHT	PRICE
RTA8001	100 cm	67,5 cm	45 cm	55,76 kg	\$ 395,00

PROLINE

THE PROFESSIONAL GARAGE TOOLS

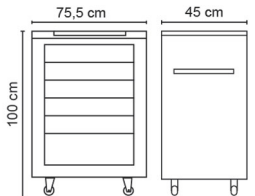
TOOL TROLLEY - 8 DRAWERS

- Sheet steel, corrosion-resistant and scratch-resistant powder coating.
- Fully opening drawer on telescopic ball bearing slides.
- 4 Castors ø 100mm: 2 fixed and 2 steering (one with brake)
- ABS reinforced worktop, solid and sturdy.

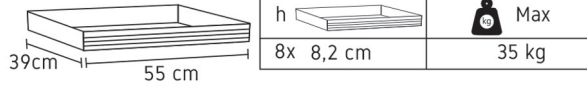

CODE NO	HEIGHT	WIDTH	DEPTH	WEIGHT	PRICE
RTY8001	100 cm	75,5 cm	45 cm	60,70 kg	\$ 425,00

MONOLINE

THE PROFESSIONAL GARAGE TOOLS



TOOL BENCH - 3050

- Sheet steel, corrosion-resistant and scratch-resistant powder coating.
- Fully opening drawer on telescopic ball bearing slides.
- 4 Castors ø 100mm: 2 fixed and 2 steering (one with brake)
- Side compartment with shelf
- Ply-wood covered with Oil-proof, rubber-coated worktop



CODE NO	HEIGHT	WIDTH	DEPTH	WEIGHT	PRICE
RTA3050	85 cm	113 cm	45 cm	66 kg	\$ 425,00

MONOLINE

THE PROFESSIONAL GARAGE TOOLS



TOOL BENCH - 3060

- Sheet steel, corrosion-resistant and scratch-resistant powder coating.
- Fully opening drawer on telescopic ball bearing slides.
- 4 Castors ø 100mm: 2 fixed and 2 steering (one with brake)
- Side compartment with shelf
- Ply-wood covered with Oil-proof, rubber-coated worktop



CODE NO	HEIGHT	WIDTH	DEPTH	WEIGHT	PRICE
RTA3060	85 cm	113 cm	45 cm	58 kg	\$ 385,00

MONOLINE
THE PROFESSIONAL GARAGE TOOLS



PROMAX TOOL BENCH - 3070

- Sheet steel, corrosion-resistant and scratch-resistant powder coating.
- Fully opening drawer on telescopic ball bearing slides.
- 4 Castors \varnothing 100mm: 2 fixed and 2 steering (one with brake)
- Side compartment with shelf
- Ply-wood covered with Oil-proof, rubber-coated worktop

h	Max
4x 10 cm	35 kg
20 cm	35 kg

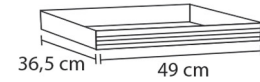

CODE NO	HEIGHT	WIDTH	DEPTH	WEIGHT	PRICE
RTA3070	85 cm	113 cm	45 cm	66 kg	\$ 465,00

MONOLINE
THE PROFESSIONAL GARAGE TOOLS



PROMAX TOOL BENCH - 3090

- Sheet steel, corrosion-resistant and scratch-resistant powder coating.
- Fully opening drawer on telescopic ball bearing slides.
- 4 Castors \varnothing 100mm: 2 fixed and 2 steering (one with brake)
- Side compartment with shelf
- Ply-wood covered with Oil-proof, rubber-coated worktop

h	Max
6x 10 cm	35 kg
3x 20 cm	35 kg
1x 10 cm	35 kg

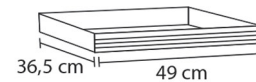

CODE NO	HEIGHT	WIDTH	DEPTH	PRICE
RTA3090	100 cm	115 cm	45 cm	\$ 550,00

MONOLINE
THE PROFESSIONAL GARAGE TOOLS

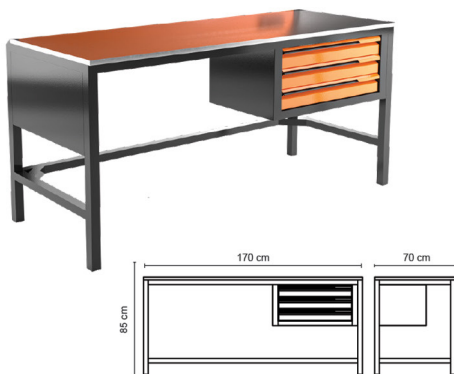

WORK BENCH

- Sheet steel, corrosion-resistant and scratch-resistant powder coating.
- Fully opening drawer on telescopic ball bearing slides.
- Ply-wood covered with Oil-proof, rubber-coated worktop
- All steel fully welded workbench frame.
- Storage options include cabinets and drawers.

h	Max
3x 10 cm	35 kg

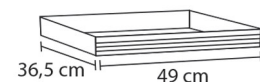

CODE NO	HEIGHT	WIDTH	DEPTH	PRICE
RTA9001	85 cm	170 cm	70 cm	\$ 435,00

MONOLINE

THE PROFESSIONAL GARAGE TOOLS

WORK BENCH WITH BACK WALL

- Sheet steel, corrosion-resistant and scratch-resistant powder coating.
- Fully opening drawer on telescopic ball bearing slides.
- Ply-wood covered with Oil-proof, rubber-coated worktop
- All steel fully welded workbench frame.
- Storage options include cabinets and drawers.

	Max		
10 cm	35 kg	36,5 cm	49 cm

CODE NO	HEIGHT	WIDTH	DEPTH	PRICE
RTA9101	205 cm	170 cm	70 cm	\$ 600,00



MONOLINE

THE PROFESSIONAL GARAGE TOOLS

WORK BENCH 92

- Sheet steel, corrosion-resistant and scratch-resistant powder coating.
- Fully opening drawer on telescopic ball bearing slides.
- Ply-wood covered with Oil-proof, rubber-coated worktop
- All steel fully welded workbench frame.
- Storage options include cabinets and drawers.

h	Max		
4x 10 cm	35 kg	36,5 cm	49 cm
20 cm	35 kg		

CODE NO	HEIGHT	WIDTH	DEPTH	PRICE
RTA9201	201 cm	137 cm	75 cm	\$ 900,00



MONOLINE

THE PROFESSIONAL GARAGE TOOLS

WORK BENCH 93

- Sheet steel, corrosion-resistant and scratch-resistant powder coating.
- Fully opening drawer on telescopic ball bearing slides.
- Ply-wood covered with Oil-proof, rubber-coated worktop
- All steel fully welded workbench frame.
- Storage options include cabinets and drawers.

	Max		
10 cm	35 kg	36,5 cm	49 cm
20 cm	35 kg		

CODE NO	HEIGHT	WIDTH	DEPTH
RTA9301	200 cm	200 cm	75 cm



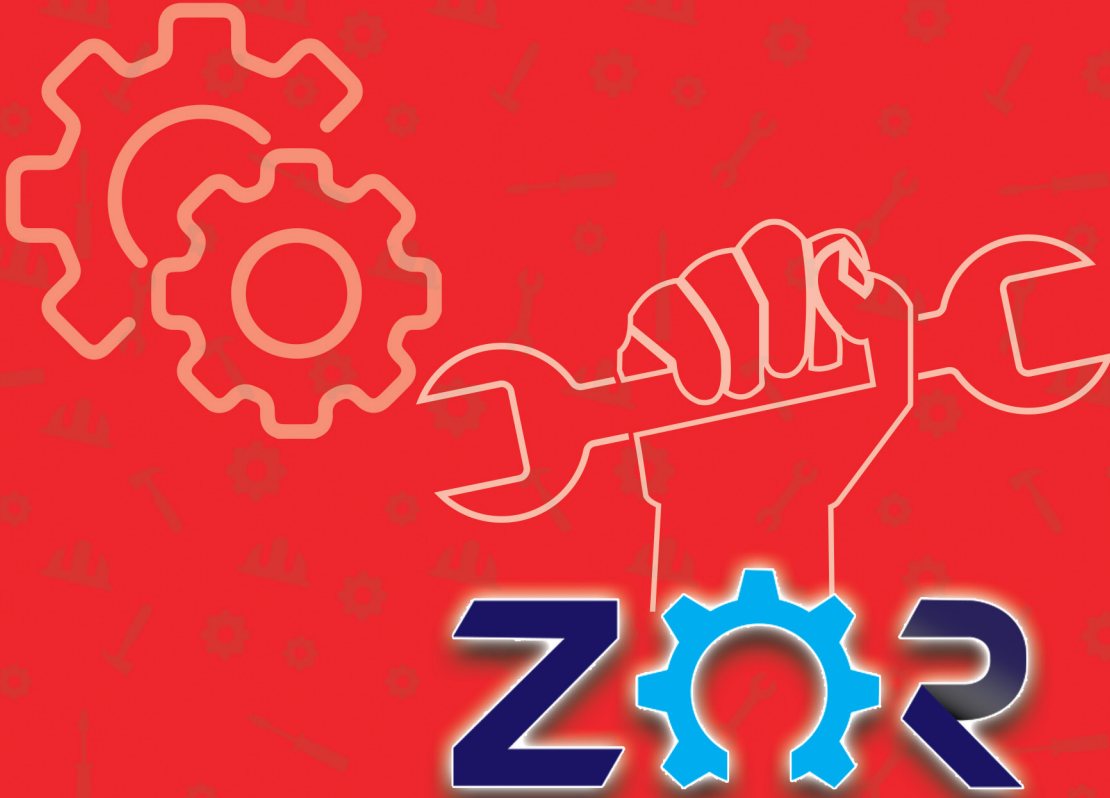

HAND TOOLS



www.eaglegrouptr.com

 eaglegroupturk  eaglegroup  +905380959929

Turkey BRANCH: Cumhuriyet Mahalles – Nazim Hkmet Buluvari No:91 Concept plaza
Ablok – Kat: 8 – D:56 Esenyurt - Istanbul - Mehmet.ezz@eaglegrouptr.com

EGYPT HEAD OFFICE:

3 Hashem AL Ashkar st. El Nozha El Gdeda
6th Floor – Cairo
+20226214161 / +226215983 / +201060555828
www.eagletranseg.com info@eagletranseg.com

KSA BRANCH:

Al Tawba st Office No.1
Makkah Tower, Sharafia,
Jeddah, KSA - TEL &
FAX : +966541011009